

# MegaMOS™ Power MOSFET

## IRFP 460

$$V_{DSS} = 500 \text{ V}$$

$$I_{D(\text{cont})} = 20 \text{ A}$$

$$R_{DS(\text{on})} = 0.27 \Omega$$

N-Channel Enhancement Mode, HDMOS™ Family

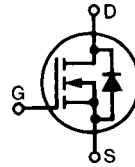

Symbol	Test Conditions	Maximum Ratings	
$V_{DSS}$	$T_J = 25^\circ\text{C}$ to $150^\circ\text{C}$	500	V
$V_{DGR}$	$T_J = 25^\circ\text{C}$ to $150^\circ\text{C}$ ; $R_{GS} = 1 \text{ M}\Omega$	500	V
$V_{GS}$	Continuous	$\pm 20$	V
$V_{GSM}$	Transient	$\pm 30$	V
$I_{D25}$	$T_C = 25^\circ\text{C}$	20	A
$I_{DM}$	$T_C = 25^\circ\text{C}$ , pulse width limited by $T_{JM}$	80	A
$I_{AR}$		20	A
$E_{AR}$	$T_C = 25^\circ\text{C}$	28	mJ
$dv/dt$	$I_S \leq I_{DM}$ , $di/dt \leq 100 \text{ A}/\mu\text{s}$ , $V_{DD} \leq V_{DSS}$ , $T_J \leq 150^\circ\text{C}$ , $R_G = 2 \Omega$	3.5	V/ns
$P_D$	$T_C = 25^\circ\text{C}$	260	W
$T_J$		-55 ... +150	$^\circ\text{C}$
$T_{JM}$		150	$^\circ\text{C}$
$T_{stg}$		-55 ... +150	$^\circ\text{C}$
$M_d$	Mounting torque	1.15/10	Nm/lb.in.
<b>Weight</b>		6	g
Maximum lead temperature for soldering 1.6 mm (0.062 in.) from case for 10 s		300	$^\circ\text{C}$

TO-247 AD

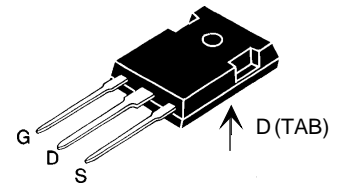

G = Gate,  
S = Source,  
D = Drain,  
TAB = Drain

### Features

- Repetitive avalanche energy rated
- Fast switching times
- Low  $R_{DS(\text{on})}$  HDMOS™ process
- Rugged polysilicon gate cell structure
- High Commutating  $dv/dt$  Rating

### Applications

- Switching Power Supplies
- Motor controls

Symbol	Test Conditions	Characteristic Values ( $T_J = 25^\circ\text{C}$ , unless otherwise specified)		
		min.	typ.	max.
$V_{DSS}$	$V_{GS} = 0 \text{ V}$ , $I_D = 250 \mu\text{A}$	500		V
$V_{GS(\text{th})}$	$V_{DS} = V_{GS}$ , $I_D = 250 \mu\text{A}$	2		V
$I_{GSS}$	$V_{GS} = \pm 20 \text{ V}_{DC}$ , $V_{DS} = 0$			$\pm 100 \text{ nA}$
$I_{DSS}$	$V_{DS} = 0.8 \cdot V_{DSS}$ , $T_J = 25^\circ\text{C}$ $V_{GS} = 0 \text{ V}$ , $T_J = 125^\circ\text{C}$			25 $\mu\text{A}$ 250 $\mu\text{A}$
$R_{DS(\text{on})}$	$V_{GS} = 10 \text{ V}$ , $I_D = 12 \text{ A}$ Pulse test, $t \leq 300 \mu\text{s}$ , duty cycle $d \leq 2 \%$	0.25	0.27	$\Omega$

Symbol	Test Conditions	Characteristic Values ( $T_J = 25^\circ\text{C}$ , unless otherwise specified)			
		min.	typ.	max.	
$g_{fs}$	$V_{DS} = 10\text{ V}; I_D = 12\text{ A}$ , pulse test	13	21	S	
$C_{iss}$	$V_{GS} = 0\text{ V}, V_{DS} = 25\text{ V}, f = 1\text{ MHz}$		4200	pF	
$C_{oss}$			450	pF	
$C_{rss}$			135	pF	
$t_{d(on)}$	$V_{GS} = 10\text{ V}, V_{DS} = 250\text{ V}, I_D = 20\text{ A}$ $R_G = 4.3\ \Omega$ , (External)		23	35	ns
$t_r$			81	120	ns
$t_{d(off)}$			85	130	ns
$t_f$			65	98	ns
$Q_{g(on)}$	$V_{GS} = 10\text{ V}, V_{DS} = 200\text{ V}, I_D = 20\text{ A}$		135	210	nC
$Q_{gs}$			28	40	nC
$Q_{gd}$			62	110	nC
$R_{thJC}$			0.45	K/W	
$R_{thCK}$		0.25		K/W	

**Source-Drain Diode**

Symbol	Test Conditions	Characteristic Values ( $T_J = 25^\circ\text{C}$ , unless otherwise specified)		
		min.	typ.	max.
$I_S$	$V_{GS} = 0\text{ V}$			20 A
$I_{SM}$	Repetitive; pulse width limited by $T_{JM}$			80 A
$V_{SD}$	$I_F = 20\text{ A}, V_{GS} = 0\text{ V}$ , Pulse test, $t \leq 300\ \mu\text{s}$ , duty cycle $d \leq 2\%$			1.8 V
$t_{rr}$	$I_F = 20\text{ A}, -di/dt = 100\text{ A}/\mu\text{s}, V_R = 100\text{ V}$		570	860 ns
$Q_{rr}$			5.7	$\mu\text{C}$

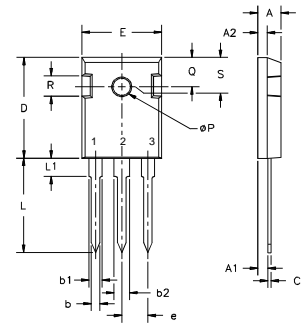
**TO-247 AD Outline**

Terminals: 1 - Gate    2 - Drain  
3 - Source    Tab - Drain

Dim.	Millimeter		Inches	
	Min.	Max.	Min.	Max.
A	4.7	5.3	.185	.209
A <sub>1</sub>	2.2	2.54	.087	.102
A <sub>2</sub>	2.2	2.6	.059	.098
b	1.0	1.4	.040	.055
b <sub>1</sub>	1.65	2.13	.065	.084
b <sub>2</sub>	2.87	3.12	.113	.123
C	.4	.8	.016	.031
D	20.80	21.46	.819	.845
E	15.75	16.26	.610	.640
e	5.20	5.72	0.205	0.225
L	19.81	20.32	.780	.800
L1		4.50		.177
∅P	3.55	3.65	.140	.144
Q	5.89	6.40	0.232	0.252
R	4.32	5.49	.170	.216
S	6.15	BSC	242	BSC

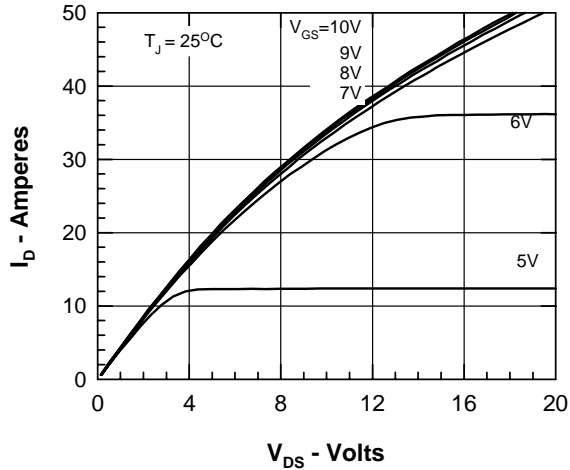

Figure 1. Output Characteristics at 25°C

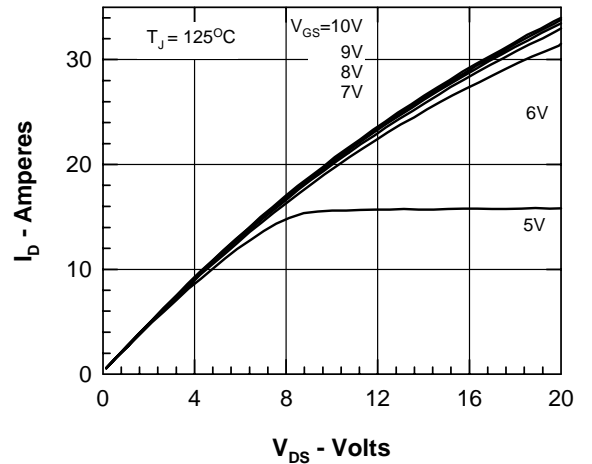

Figure 2. Output Characteristics at 125°C

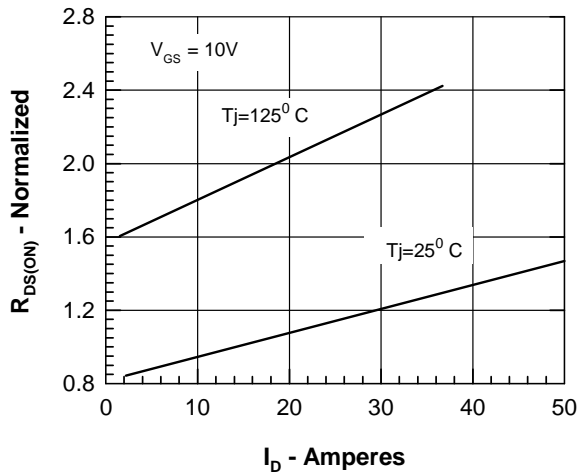

Figure 3.  $R_{DS(on)}$  normalized to value at  $I_D = 12A$

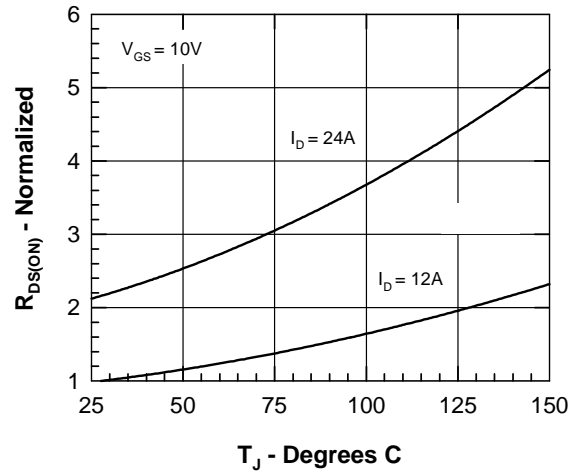

Figure 4.  $R_{DS(on)}$  normalized to value at  $I_D = 12A$

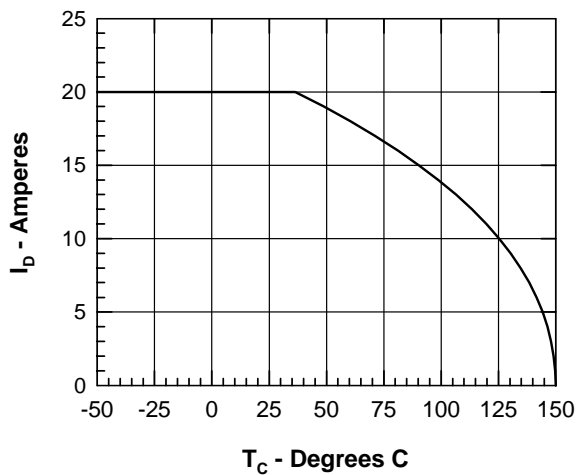

Figure 5. Drain Current vs. Case Temperature

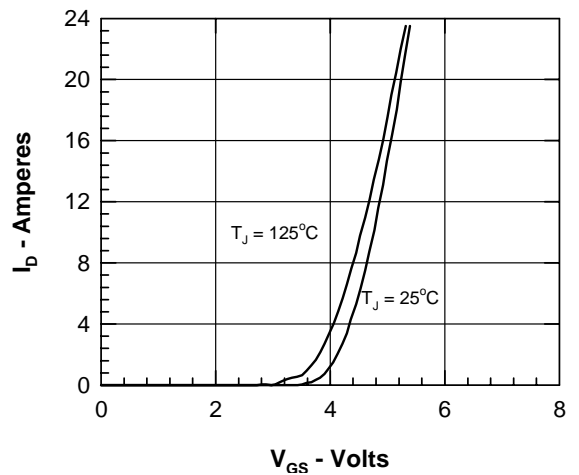

Figure 6. Admittance Curves

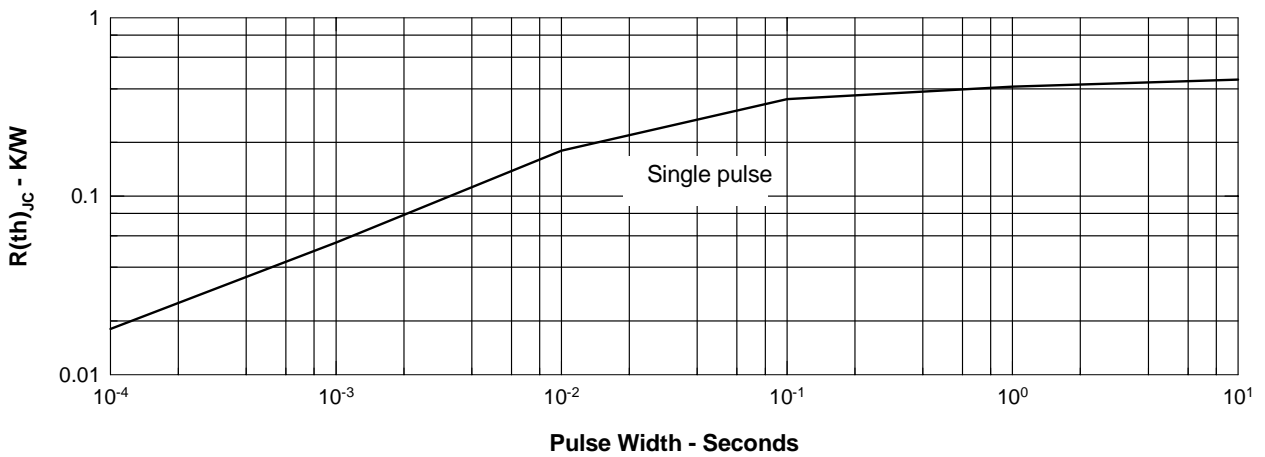
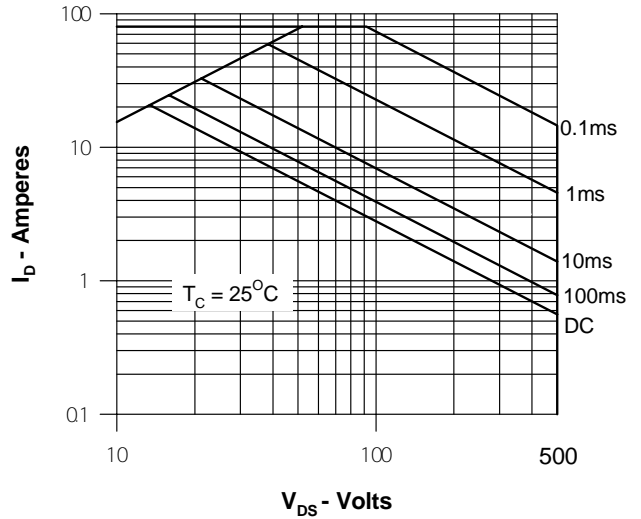
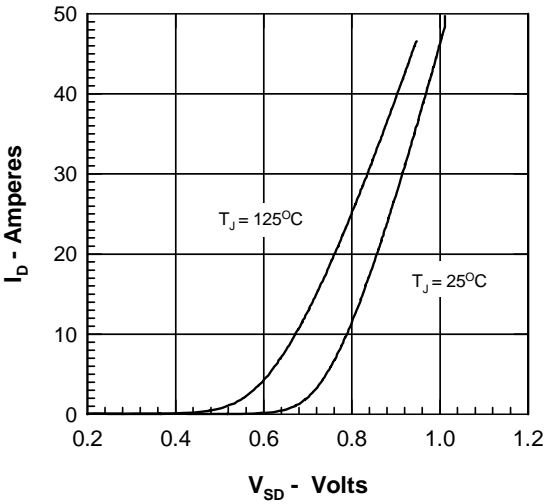
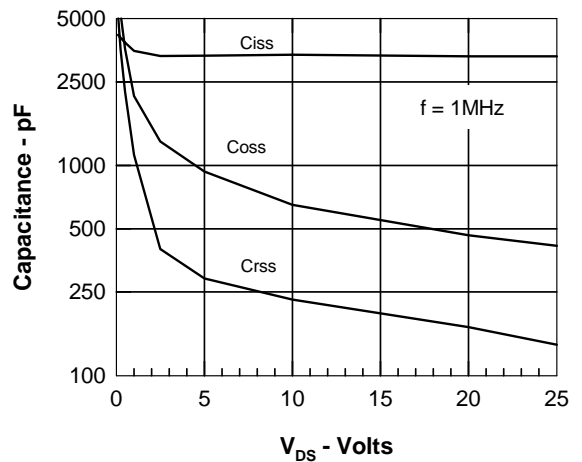
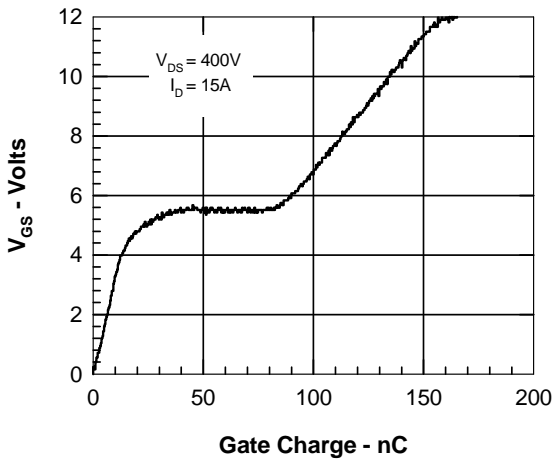

Figure 11. Transient Thermal Resistance